

Operating Instructions

Sartorius Moisture Analyzer

Model MA150

Electronic Moisture Analyzer

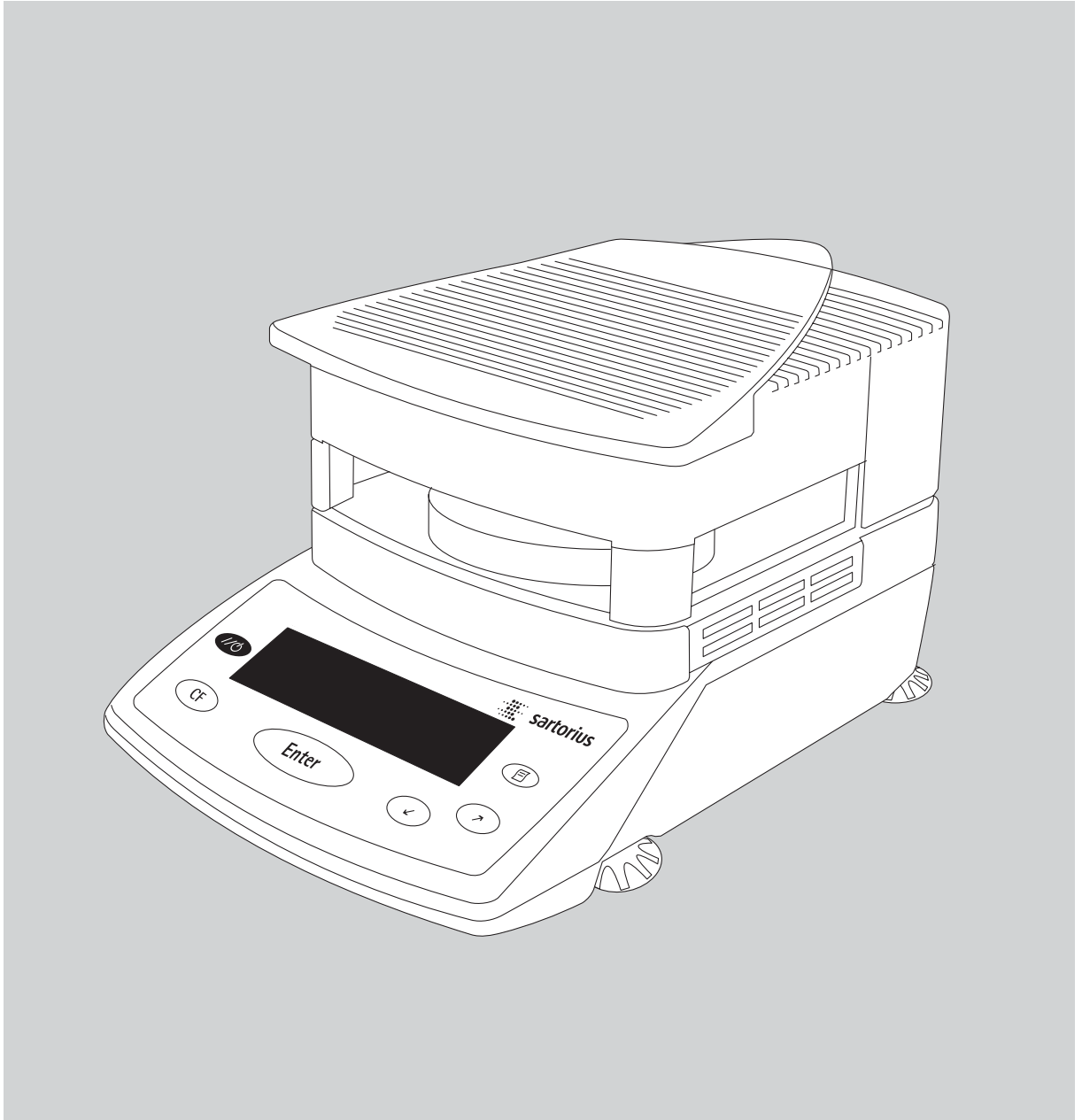

Intended Use

The MA moisture analyzer can be used for quick and reliable determination of moisture content of materials of liquid, pasty and solid substances using the thermogravimetric method.

The moisture analyzer speeds up routine procedures with the following features:

- fast analysis time, high repeatability, and gentle and uniform sample drying due to the round ceramic or quartz-rod IR heating element.
- choice of fully automatic, semi-automatic or timer modes for shutoff parameters
- options for storing up to 20 user-defined drying programs

The following features make the moisture analyzer ideal for use as an inspection, measuring and test instrument in process control and goods-in inspection:

- compact design; requires little space
- hinged sample chamber cover with wide-angle opening for easy access
- convenient and reliable control of the accuracy of the moisture analyzer according to the DIN/ISO standards by using an external calibration weight and a temperature adjustment set
- ISO/GLP compliant recording capability with pre-configured formats for print-outs of analysis results and records of temperature and weighing system adjustments
- password-protected drying parameters
- comprehensive range of accessories, including dust cover for the keypad, glass fiber filters, set of aluminum panels for replacement of glass panels over the heating element, external printer, PC software for recording results and displaying the drying curve (some of these components are optional)

The moisture analyzer meets the highest requirements placed on the accuracy and reliability of weighing results through the following features:

- excellent readability under any lighting conditions; backlit display minimizes reading errors
- removable pan draft shield makes it easy to clean the sample chamber and protects the weighing system from dirt

Symbols

The following symbols are used in these instructions:

- indicates required steps
- indicates steps required only under certain conditions
- > describes what happens after you have performed a particular step
- indicates an item in a list
- ⚠ indicates a hazard

For technical advice on applications:

Phone +49.0.551.308.3160
Fax +49.0.551.308.3495

Contents

2	Intended Use	46	Error Codes
4	Safety and Warning Information	48	Care and Maintenance
5	Getting Started	48	Service
5	Equipment Supplied	48	Repairs
6	General View of the Moisture Analyzer	48	Cleaning
7	Connecting the Moisture Analyzer to AC Power	49	Safety Inspection
8	Leveling the Moisture Analyzer	49	Disposal
8	Turning on Device, Opening/Closing Sample Chamber	50	Overview
9	Operating Design	50	Specifications
9	Keys	51	Accessories (Options)
10	Operation: Analysis and Test Functions	52	Declaration of Conformity
11	Menu Operation	53	Index
11	Data Output		Appendix
12	Error Codes		Entering General Password
12	Saving Data		Brief Instructions
13	Configuring the Moisture Analyzer		
13	Setting the Language		
14	Setting Device Parameters		
15	Entering and Changing Password		
17	Device Parameters (Overview)		
18	Information Specific to Device		
19	Basics of Moisture Analysis		
21	Preparation		
21	– Adjustment to an Existing Measuring System		
22	– Preparing a Sample		
24	Operating the Moisture Analyzer		
24	Setting the Drying Parameters		
24	– Drying Parameters (Overview)		
27	Example		
31	“isoTest” Calibration/Adjustment Function		
31	Heater Adjustment		
31	Weighing System Settings		
35	Hardware Tests		
37	Data Output		
37	Output to the Moisture Analyzer Display		
39	Interface Port		
40	Data Output Format		
42	Data Input Format		
44	Pin Assignment Chart		
45	Cabling Diagram		

Warning and Safety Information

This moisture analyzer complies with the European Council Directives as well as international regulations and standards for electrical equipment, electromagnetic compatibility, and the stipulated safety requirements. Improper use or handling, however, can result in damage and/or injury.

To prevent damage to the equipment, read these operating instructions thoroughly before using your moisture analyzer. Keep these instructions in a safe place.

Follow the instructions below to ensure safe and trouble-free operation of your moisture analyzer:

- △ Use the moisture analyzer only for performing moisture analysis of samples. Any improper use of the analyzer can endanger persons and may result in damage to the analyzer or other material damage
- △ Do not use this moisture analyzer in a hazardous area/location; operate it only under the ambient conditions specified in these instructions
- △ Materials liable to catch fire or explode may not be used as samples for moisture analysis
- △ The requirements pertaining to applicable installation regulations must be followed when using electrical equipment in systems and environmental conditions with increased safety requirements
- The moisture analyzer may be operated only by qualified persons who are familiar with the properties of the sample to be analyzed
- △ Before use, ensure that the voltage rating printed on the manufacturer's label is identical to your local line voltage (see "Connecting the Moisture Analyzer to AC Power") in the chapter entitled "Getting Started"
- A power supply, with grounding conductor, is supplied with the device
- The only way to switch the power off completely is to unplug the power cord
- Position the power cord so that it cannot come into contact with hot surfaces of the moisture analyzer
- Use only extension cords that meet applicable norms and that have a protective grounding conductor

- Disconnecting the ground conductor is not permitted
- Use only Sartorius accessories and options as these are optimally designed for use with your moisture analyzer

Note on installation:
The operator shall be responsible for any modifications to Sartorius equipment and must check and, if necessary, correct these modifications. On request, Sartorius will provide information on the minimum operating specifications (in accordance with the Standards for defined immunity to interference).

- Protect the moisture analyzer from contact with liquid
- If there is visible damage to the moisture analyzer or power cord: unplug the equipment and lock it in a secure place to ensure that it cannot be used
- △ Clean your moisture analyzer in accordance with the cleaning instructions (see "Care and Maintenance")

Do not open the analyzer housing. If the seal is broken, this will result in forfeiture of all claims under the manufacturer's warranty.

- Please contact the Sartorius customer service center should any problems arise with your moisture analyzer.



Warning: Severe burns

- When setting up the moisture analyzer, leave enough space to prevent heat from building up and to keep your analyzer from overheating:
 - leave 20 cm around the moisture analyzer
 - leave 1 m above the device
- Do not put any flammable substances on, under or near the moisture analyzer because the area around the heater unit will heat up
- Be careful when removing the sample from the chamber since the sample, the heater unit and the sample pan used can still be extremely hot
- Prevent excess heat build-up around the analyzer

Potential risk of damage and injury to persons with certain samples:



Fire



Explosion

- Flammable or explosive substances
- Substances that contain solvents
- Substances that release flammable or explosive gases or vapors during the drying process

In some cases, it is possible to operate the moisture analyzer in an enclosed nitrogen atmosphere to prevent the vapor released during drying from coming into contact with oxygen in the surrounding atmosphere. Check on a case-to-case basis whether this method can be used; installation of the analyzer in too small an enclosed space may affect functionality of the device (for instance, through excessive heat build-up within the analyzer). When in doubt, perform a risk analysis.

The user assumes liability and responsibility for any damage caused.



Poisoning



Caustic burns

- Substances containing toxic or caustic or corrosive components: These may only be dried in a fume hood or beneath an extraction hood. The value for the "lower toxic limit" in a work area must not be exceeded.

Corrosion:

- Substances that release aggressive vapors during the heating process (such as acids): In this case we recommend that you work with small sample quantities. Otherwise vapors may condense on cold housing parts and cause corrosion.

The user assumes liability and responsibility for any damage caused.

Getting Started

The moisture analyzer comprises a heater unit, weighing system and operating unit. In addition to the socket for AC power (mains supply), it also has an interface port for connecting peripheral devices (such as PC, printer, etc.).

Storage and Shipping Conditions

Permissible storage temperature:
0 to +40°C

Do not unnecessarily expose the moisture analyzer to extreme temperatures, moisture, shocks or vibration.

Unpacking the Moisture Analyzer

- After unpacking the moisture analyzer, inspect the device immediately for any visible damage that may have been caused by rough handling during shipment
- If damage has occurred: Refer to “Safety inspection” in the “Care and maintenance” chapter.

Save the box and all other packaging until you have successfully installed your moisture analyzer. Only the original packaging provides the best protection for shipment. Before packing your moisture analyzer, unplug all connected cables to prevent damage.

Equipment Supplied

The equipment supplied includes the following:

- Moisture analyzer
- Power cord
- Pan support
- Pan draft shield
- Dust cover for keypad
- 80 disposable aluminum sample pans
- 1 pair of forceps

Installation Instructions

The moisture analyzer has been designed to provide reliable results under normal ambient conditions in the laboratory and in industrial use. When choosing a location to set up your moisture analyzer, observe the following to work with speed and accuracy:

- Set up the moisture analyzer on a stable, even surface that is not exposed to vibration and level the device using the four leveling feet
- Avoid placing the analyzer in close proximity to a heater or exposing it to direct sunlight
- Avoid exposing the moisture analyzer to extreme temperature fluctuations
- Protect the moisture analyzer from drafts (open windows or doors)
- Provide the moisture analyzer with as much protection from dust as possible
- Protect the moisture analyzer from aggressive chemical vapors
- Do not expose the analyzer to extreme moisture
- Ensure the analyzer is located in a place where excessive heat cannot build up. Leave enough space between the moisture analyzer and materials that are affected by heat.

Conditioning the Moisture Analyzer

Moisture in the air can condense on the surfaces of a cold moisture analyzer whenever it is brought into a substantially warmer place. On transferring the moisture analyzer to a warmer area, make sure to condition it for about 2 hours at room temperature (unplugged from power). Afterwards, if you keep the moisture analyzer connected to AC power, the continuous positive difference in temperature between the inside of the moisture analyzer and the outside will practically rule out the effects of moisture condensation.

Setting up the Moisture Analyzer

- Attach components in this order:
 - Dust cover over keypad
 - Pan draft shield
 - Pan support; turn carefully to left or right, press gently until it stops and snaps into place
 - Disposable sample pan

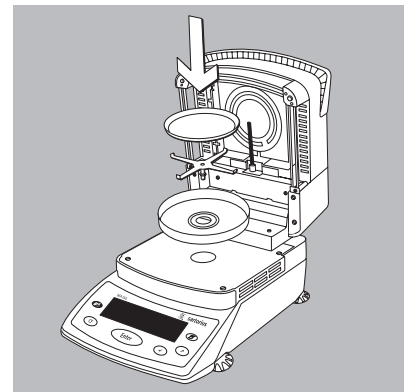

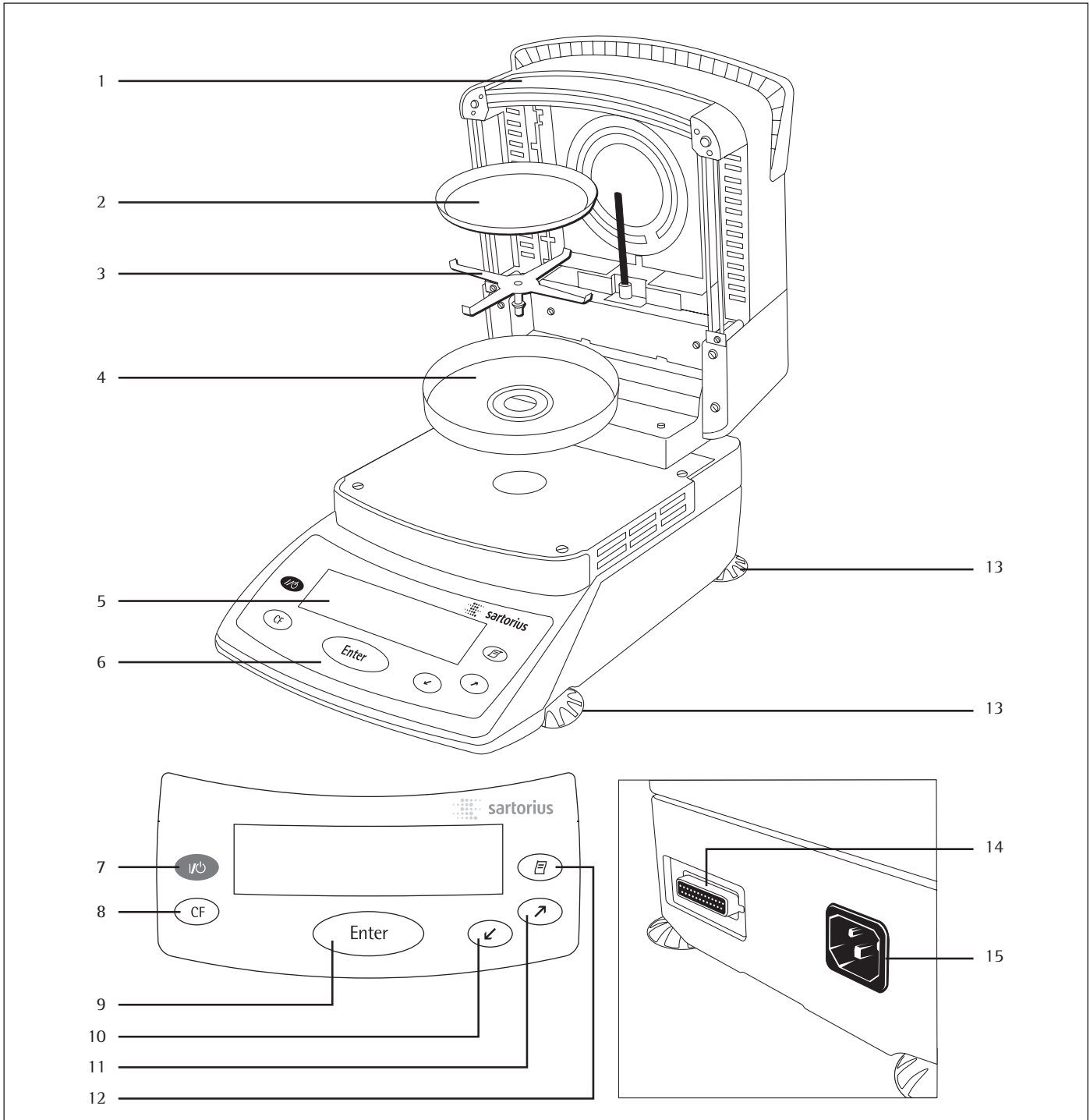

Pos.	Description	Order no. for replacement	No.	Designation	Order no. for replacement
1	Hinged cover with heating element		10	"Down/Back" key	
2	Disposable sample pan	6965542 (80 pcs.)	11	"Up/Forward" key	
3	Pan support	69MA0092	12	Print key	
4	Pan draft shield	69MA0093	13	Leveling foot	
5	Display		14	Interface port	
6	Keypad		15	Power socket	
7	On/off key			Not shown:	
8	CF key (clear function)			Dust cover for keypad	6960MA02
9	Enter key (confirm)			1 pair of forceps	69MA0072

Connecting the Moisture Analyzer to AC Power

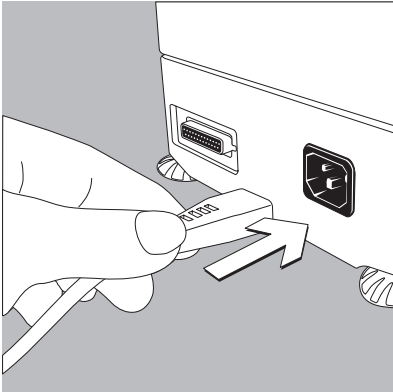

- Check the voltage rating and plug design

- The heating unit of the moisture analyzer has been factory-set to either 230 V or 115 V for technical reasons. The voltage has been set to the rating specified on your order. The voltage setting is shown on the manufacturer's label (see the bottom of the analyzer), for example:
 - 230 volts: MA150-...230..
 - 115 volts: MA150-...115..

△ If they do not match:

Do not operate your moisture analyzer; contact your local Sartorius office or dealer.

Use only

- Original power cords
- Power cords approved by a certified electrician
- If you need to connect an extension cord:
 - Use only a cable with a protective grounding conductor

- Connecting the moisture analyzer, rated to Class 1, to power supply (mains supply):
The moisture analyzer must be plugged into a properly installed wall outlet which has a protective grounding conductor (PE)

Note:

This equipment has been tested and found to comply with the limits for a Class A digital device, pursuant to Part 15 of the FCC rules. These limits are designed to provide reasonable protection against harmful interference when the equipment is operated in a commercial environment. This equipment generates, uses and can radiate radio frequency energy and, if not installed and used in accordance with the instruction manual, may cause harmful interference to radio communications. Operation of this equipment in a residential area is likely to cause harmful interference in which case the user will be required to correct the interference at his own expense. Changes or modifications not expressly approved by Sartorius AG could void the user's authority to operate the equipment.

Safety Precautions

If you use an electrical outlet that does not have a protective grounding conductor, ensure that an equivalent protective conductor is installed by a certified electrician (as specified in the applicable regulations for installation in your country). The protective effect must not be negated by using an extension cord without a protective grounding conductor.

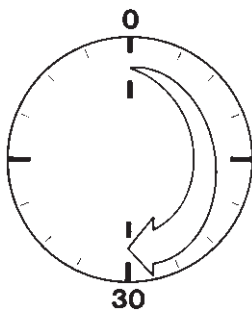
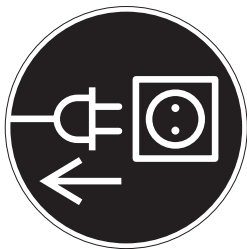

Connecting Electronic Devices (Peripherals)

- Make absolutely sure that the moisture analyzer is unplugged from the power supply before connecting/disconnecting a peripheral device (printer or PC) to or from the interface port.

Warmup Time

To return precise results, the moisture analyzer must warm up for at least 30 minutes after initial connection to AC power or after a relatively long power outage. Only after this time will the moisture analyzer have reached the required operating temperature.

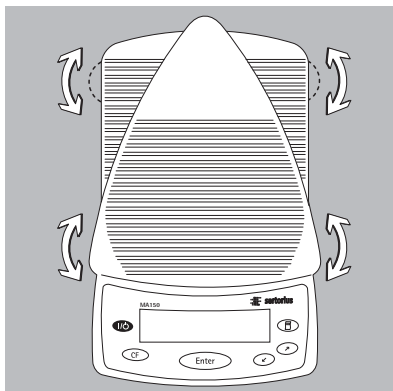

Leveling the Moisture Analyzer

Purpose:

- To compensate for unevenness at the place of installation
- This is necessary especially for testing liquid samples that need to be at a uniform level in the disposable sample pan
Always re-level the moisture analyzer after it has been moved to a different location.
- Extend or retract the front and/or rear leveling feet as needed to adjust the moisture analyzer

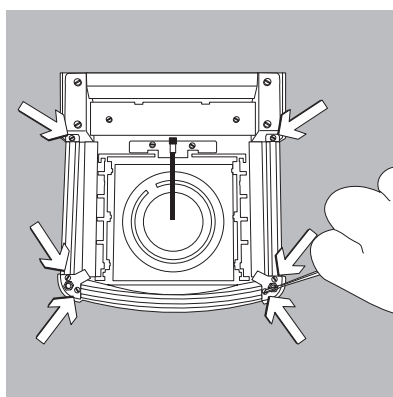

Installing the Aluminum Panels (Optional)

- △ To prevent burns, allow the glass panels to cool sufficiently before removing them
- △ Do not handle the aluminum panels with oily or greasy fingers
- △ Do not scratch the aluminum panels; do not use abrasive or corrosive substances to clean the aluminum panels
- Remove the 6 screws and remove the panel retainer
- Remove the glass panels
- Position the aluminum panels in the retainer
- Fasten the aluminum panels with the retainer and screws

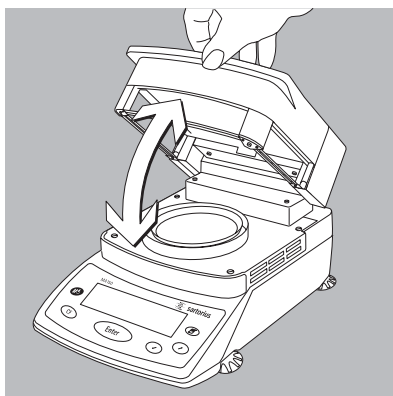

Turning on the Analyzer; Opening and Closing the Sample Chamber

- To turn on the analyzer, press the **e** key
- Opening/closing the sample chamber: Do not release the cover until it is in the fully open or fully closed position

Setting the Language

- See "Setting the Language" in the chapter entitled "Configuring the Moisture Analyzer".

Operating Design

Operation of the moisture analyzer conforms to a consistent approach, described below.

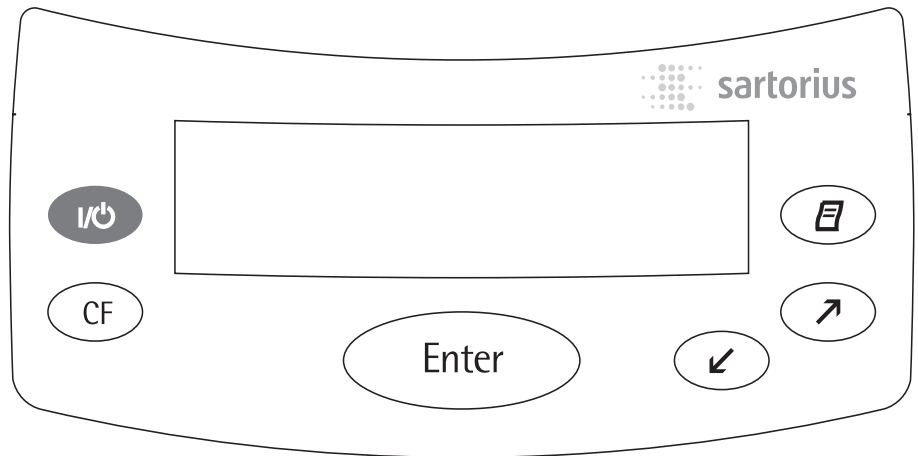

Keys

The keys have the following functions:

- e** On/off key
Turns the moisture analyzer on/off. The moisture analyzer remains in standby mode
- c** Clear Function
Cancels application functions, interrupts calibration/adjustment routines
When the operating menu is active: Closes active submenu and returns to next higher menu level
- u** Enter
During moisture analysis: Activates the selected function (e.g., tare, start, cancel)
When the operating menu is active: Confirms the setting or input displayed

- y** Down/back
When the operating menu is active: Shows the next menu item on the current menu level
When entering alphanumeric characters: Moves the cursor back to the previous character (see the next column for character sequence)
- x** Up/forward
When the operating menu is active: Shows the previous menu item on the current menu level
When entering alphanumeric characters: Moves the cursor forward to the next character (see the next column for character sequence)
- r** Print
Sends the displayed data or the active data record via the interface port to the external printer

Entering letters, special characters and numbers:

When the character at the cursor position is blinking, you can use the **y** and **x** keys to change the character. The cursor "moves" through the available characters in the following sequence:

**0 1 2 3 4 5 6 7 8 9 . - + / * =
< > () : ? ! \$ & % # @ Z Y X W
V U T S R Q P O N M L K J I H G
F E D C B A ↵ (space)**

To enter a character: Position the cursor as desired and press the **u** key

To confirm a character string: After entering the last character, press and hold the **u** key for at least two seconds

To delete a character:
Enter a "space"

Operation

There are two fundamentally different types of display:

- display for analysis and test functions
- display for menu operation (such as Setup or Program)

Analysis and Test Functions

This display is divided into 9 sections.

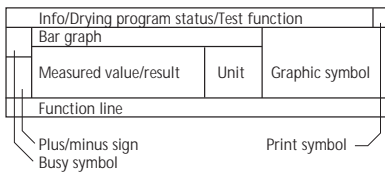

Example: Moisture Analysis

Info/Drying Program Status Line:

This line shows the following information:

- Number of the drying program selected (e.g. **P1**)
- Drying temperature set, e.g. **105°C**
- Criterion for end-point recognition (e.g. **Autom**)
- Current temperature
- Elapsed drying time

Busy symbol:

The symbol is shown here whenever the moisture analyzer is processing a function activated by pressing a key.

Plus/minus sign:

A plus or minus sign (+ or -) is shown here for the weight value or a calculated value (such as a percentage).

Bar graph:

The bar graph is shown during moisture analysis if the "Initial Weight" option in the drying program is set to **On**.

The following symbols may appear:

- Bar graph with separator tags
- Target value - 20%
- = Target value
- + Target value +20%

Measured value/result:

This section shows the weight or calculated value.

Unit:

Once the weighing system reaches stability, the weight unit or calculation unit is displayed here.

Graphic symbols:

The symbols shown here indicate the current operating status of the moisture analyzer. Example:



Drying in progress

Print symbol:

The following symbol is shown here during the printout of analysis results and other data:

- Printing

Function line:

This line indicates the functions that can be activated by pressing \cup (inverse display), such as Setup menu, Program menu, "Tare", "Start", or "Cal" (calibration).



This line is also used to output error text, overwriting the complete line.

Menu Operation

This display is divided into two sections.

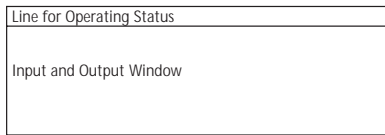

Status line:

The status line indicates the function of the current screen page. In the Setup menu, the current menu path for the displayed information is shown in this line.

Example for Setup, Language:



Input and Output Window:

This window contains either detailed information (such as that for the heater program selected) or a selection list. Selected items are displayed inversely (white letters on a black background). Letters, numbers, and special characters can also be entered in this window when an input field is active.

Example for Setup, Language:



The following symbol can also appear in the input/output window:

- This symbol indicates the stored setting

Parameter Settings

Parameters are summarized in menus that have several levels.

Example:

- Select parameter: Use the \times and y keys to select **SETUP** in the function line and confirm with \cup
- Use \times and y to scroll within a menu level
- Select menu item (open a submenu): Press \cup

Configuring parameters:

- Press \times and y repeatedly until parameter setting is highlighted (inverse display)
- Confirm parameter: Press \cup

Changing the value of a parameter:

Select parameter:

- Press \times and y repeatedly until parameter setting is highlighted (inverse display)

Entering alphanumeric characters:

- Changing flashing character: Press the \times and y keys until the desired character is displayed and confirm with \cup
- Confirm parameter: Press \cup

Back:

- Press \subset

Exit setup: Press \subset

Data Output

An interface port is provided for connecting:

- printer
- status display
- programmable logic controller (PLC)
- computer

Printer

The data format for output to an external printer can be selected; the ISO/GLP printout meets the corresponding requirements.

ISO: International Organization for Standardization

GLP: Good Laboratory Practice

See "Data Output Functions" in the chapter entitled "Operating the Moisture Analyzer" for a detailed description of data output options.

Interface Port

Instead of connecting an external printer to the communication port, you may wish to connect a status display, a programmable logic controller or a computer.

See "Data Output Functions" in the chapter entitled "Operating the Moisture Analyzer" for a detailed description of data output options.

Error Codes

If a key is pressed that has no function or is blocked, the error is indicated as follows:

- a double-beep is sounded as an acoustic signal if the key has no function
- an error message indicates invalid input
- an error code or error message indicates incorrect operation

The response to operator errors is identical for all operating modes. See the chapter entitled “Error Codes” for a detailed explanation of error messages.

Saving Data

Storing Parameter Settings

The most recent Setup menu parameter and drying program settings are active when you switch on the moisture analyzer. Factory settings may be restored at any time.

Storing Settings

Access to the following can be password-protected:

- user-defined drying programs
- the device parameter menu
- isoTEST functions

If no password is assigned, all users can access the SETUP device parameters and drying program settings without entering a password.

If you assign a password and then forget what the word is, you can use the General Password (see Appendix) to access these menus.

Configuring the Moisture Analyzer

Purpose

You can configure your moisture analyzer to meet individual requirements by entering user data and setting selected menu parameters in the Setup menu.

The Setup menu is divided into:





- Language
- Device parameters
- isoTEST
- Device information

Setting the Language

5 languages are available for the display:

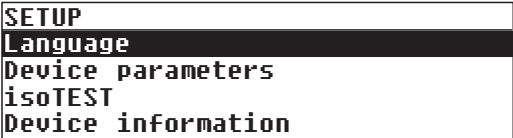
- German
- English (factory setting)
- U.S. mode (English with U.S. date/time)
- French
- Italian
- Spanish

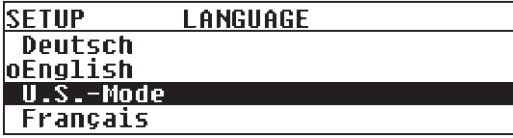
Example: Selecting "U.S.-Mode" as the Language

Step	Key (or instruction)	Display/Printout
1. Select SETUP in the function line and confirm	x or y u	 <pre> SETUP Language Device parameters isoTEST Device information </pre>
2. Confirm Language menu item	u	 <pre> SETUP LANGUAGE Deutsch English U.S.-Mode Français </pre>
3. Select " U. S. - Mode " as the language	x	 <pre> SETUP LANGUAGE Deutsch English U.S.-Mode Français </pre>
4. Confirm	u	 <pre> SETUP LANGUAGE Deutsch English U.S.-Mode Français </pre>
5. Exit Setup	c c	 <pre> P1 105°C Auto. + 0.000g SETUP PROGRAM TARE </pre>

Setting Device Parameters (DEVICE)

Purpose

Device configuration, i.e. to meet individual requirements by selecting predefined menu parameters in the Setup menu. Access to the menu may be password-protected.

Features

Device parameters are combined into the following groups (1st menu level):

- Password
- User ID
- Interface
- Drying report
- Clock
- Display contrast
- Acoustic signal
- Function of external switch
- Factory settings

The following parameters can be displayed, entered and changed:

Password:

- Password for the device parameters, drying programs and isoTEST functions

User ID:

- Text line with up to 20 characters for GLP report header to identify user.

Interface:

- SBI operating mode
Simple record of analysis results for PC or external printer, factory setting for YDP03-OCE printer
Configurable: baud rate, number of data bits, parity, stop bits, handshake
- xBPI operating mode
Function-oriented interface with transparent data transfer
Network address: enter a number from 0 to 31; factory setting: 0

Drying report:

- Select one of three display options for the drying report:
 - results only
 - with GLP/drying parameters
 - as per configuration: define which parameters are to be output (GLP head, program identifier, header line 1, header line 2, heater parameters, start criteria, shutoff criteria, start weight, intermediate result, end weight, end result and name field).

Clock:

Set time of day (hh.mm.ss; 24 hour clock) and date (dd.mm.yy; in U.S. mode: mm.dd.yy)

Display contrast:

- Set contrast/angle of display (enter a number from 0 to 4; factory setting: 2)

Acoustic signal:

- Switch signal function on or off

Function of the external switch:

- Configure switch to activate one of the following functions: Print key, Enter key, CF key or bar code reader/ additional keypad

Factory setting:

- Parameters: 'o' is used to denote factory settings (listed from page 17 onwards).

Preparation

Display existing device parameters

- Select the Setup menu:

Use **x** or **y** to select SETUP in the function line and confirm with **u**

- > SETUP is displayed:

SETUP
Language
Device parameters
isoTEST
Device information

- Select Device parameters: Press the **y** key and press **u** to confirm

If no password has been assigned, access to the SETUP device parameters is provided to all users without needing to enter a password

If a password has been assigned:

- > The password prompt is displayed

SETUP	PASSW.CHECK
Enter password:	

- If access is password-protected: Enter all of the password characters using **x** and **y** and press **u** to confirm
- Confirm password and display device parameters: Press **u**

- > Device parameters are displayed:

SETUP	DEVICE
Password	
Interface	
Display contrast	
Acoustic signal	

Entering or Changing Password

- Password for access to the following functions (up to 8 characters):
 - SETUP device parameters
 - Drying programs
 - isoTEST setup

- Display device parameters (see "Display existing device parameters" in "Preparation" section)

- Record the password here:

Password =

If a password has been assigned but forgotten:

- Enter General Password (see Appendix)
- Confirm password and display device parameters: Press **u**
- > Device parameters are displayed (see above)

- Select the "Password" device parameter (if configured) and confirm: Press **u**

- > Password: and any existing password is displayed:

SETUP	DEVICE	PASSWORD
Password:		12345678

- Enter new password: Enter digits and letters (max. 8 characters) with **x** or **y** and confirm with **u**
If the password field is blank, no password has been assigned.

- Confirm input: Press **u**

- Exit Setup menu: Press the **c** key twice

Additional Functions

Print out parameter setting:

- When device parameters are displayed: Press the **r** key
- > Printout (example)
Lines with more than 20 characters are truncated

```

-----
14.07.2006      12:40
Model MA150Q-000230V
Ser. no.      18701636
Vers. no.     01-50-01
ID
-----

```

```

SETUP
      DEVICE
-----

```

```

User ID
  User ID:

Interface
  SBI
  Baud rate      1200 baud
  Number of data bi 7 data bits
  Parity
                Odd
  Number of stop bi 1 stopbit
  Handshake mode
  Hardware handshake after 1 char
  Drying report  with GLP/drying parameters
  Clock
  Acoustic signal On
  Display contrast 2
  External T function
  Print button
-----

```

Reset device parameters to factory settings:

- Select the Setup menu: Use the **x** or **y** keys to select **SETUP** in the function line and press **u** to confirm
- > SETUP is displayed:







SETUP
Language
Device parameters
isoTEST
Device information

- Select Device parameters: Press the **y** key and press **u** to confirm
- If access is password-protected: enter the password as described above
- Confirm password and display device parameters: Press **u**
- > Device parameters are displayed:

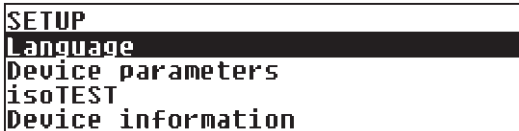
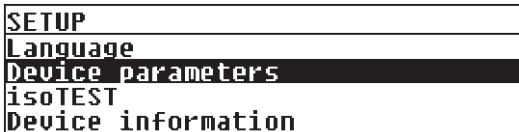
SETUP	DEVICE
Interface	
Display contrast	
Acoustic signal	
Factory settings	

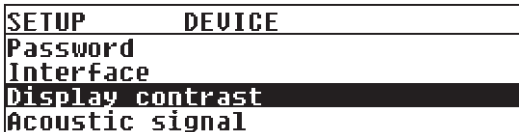
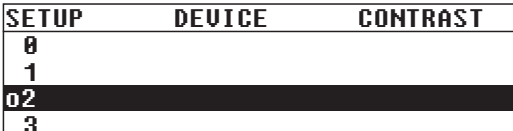
- Select **Factory settings**: Press the **y** key 4 times
- Confirm factory settings: Press **u**
- To cancel operation at this point: Press **c**
- Select Yes and confirm. Press **y** and press **u**
- Exit Setup menu: Press the **c** key 3 times

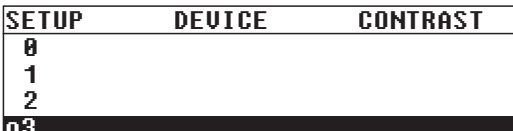
Example:
Set display contrast to "3"

Step	Key (or instruction)	Display/Printout
1. Select SETUP in the function line	x or y	
2. Confirm SETUP	u	
3. Select Device parameters	y	
4. Confirm Device parameters	u	
5. Select Display contrast	5 x y	
6. Confirm Display contrast	u	
7. Select contrast setting 3	x or y (repeatedly)	
8. Store contrast setting	u	
9. Exit "Device parameters" setup	3 x c	

Device Parameters (Overview)

- o Factory settings
- √ User-defined setting

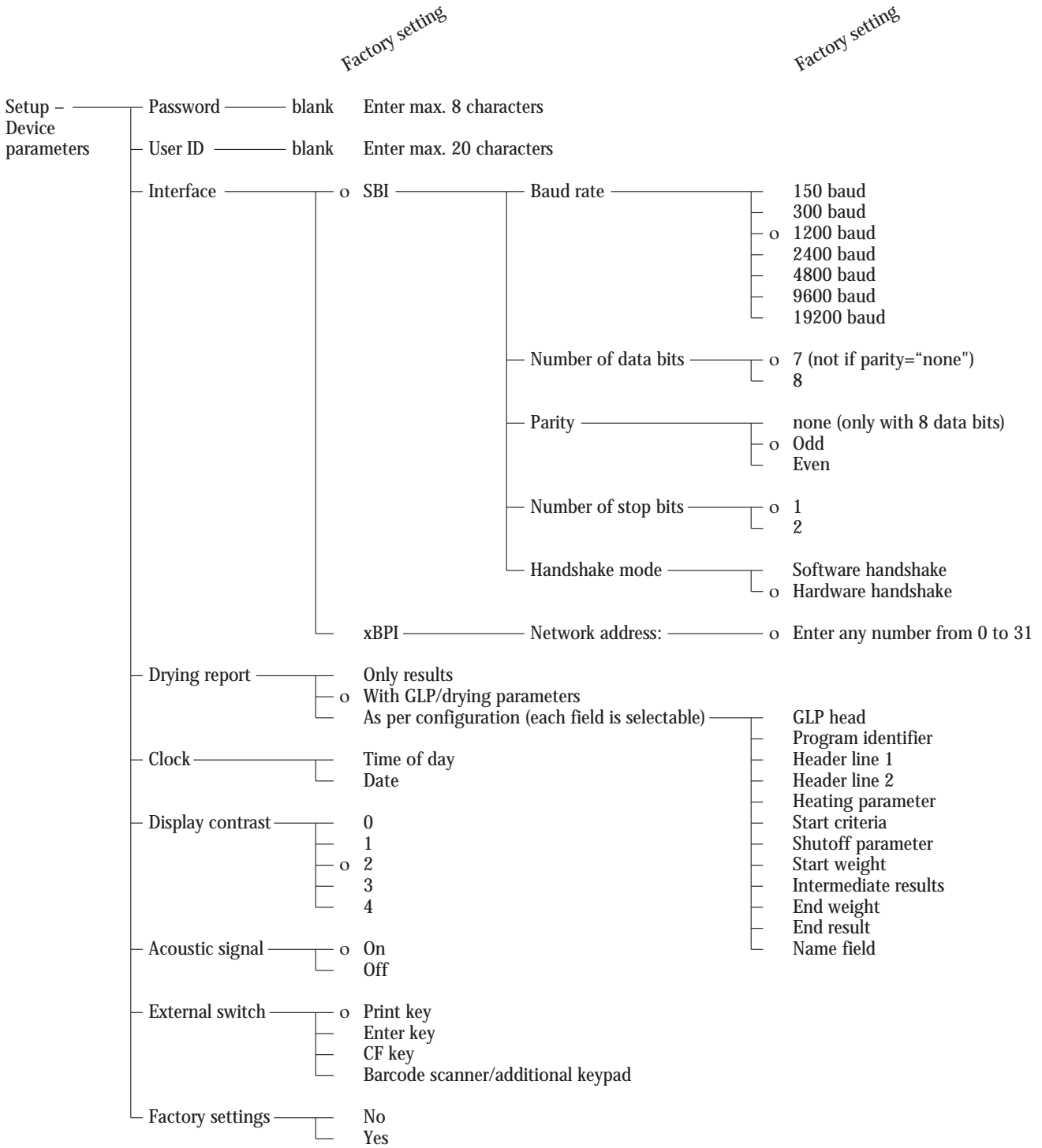

Device Information

Purpose

Display of device information

Display Device Information

- Select the Setup menu:
Use the **x** or **y** key to select **SETUP** in the Function line and press **u** to confirm

> SETUP is displayed:

SETUP
Language
Device parameters
isoTEST
Device information

- Select **Device information**:
Press the **y** key three times and press **u** to confirm

> Device information is displayed

SETUP	INFO
Version no.:	01-50-01
W.sys.ver.#:	00-25-04
Model:	MA150Q
Serial no.:	98706913

- Exit the Setup menu:
Press the **c** key twice

- Print device information:
Press the **r** key

> Printout (Example)

```
-----  
14.07.2006      12:40  
Model MA150Q-000230V  
Ser. no.      18701636  
Vers. no.     01-50-01  
(Operating program version)  
ID  
-----
```

```
SETUP  
      INFO  
-----  
Vers. no.      01-50-01  
(Operating program version)  
Scale version: 00-25-04  
(Progr. vers. of weighing system)  
Model:        MA150Q-000230V  
Serial no.    18701636  
-----
```

- Return to Setup menu:
Press the **c** key

- Exit the Setup menu:
Press the **c** key twice

> Previous status is restored

Basis of Moisture Analysis

Purpose

The MA moisture analyzer can be used for quick and reliable determination of the moisture content of materials of liquid, pasty and solid substances using the thermogravimetric method.

Material

The moisture of a material is often mistakenly equated to its water content. In fact, the moisture of a material includes all of the volatile components which are emitted when the sample is heated, irrespective of the type of material. Among such volatile substances are:

- water
- fats
- oils
- alcohols
- organic solvents
- flavorings
- volatile components, products of decomposition (when a sample is overheated)

There are many methods for determining the moisture content of a substance. These methods can be divided into two categories:

When absolute methods are used, the moisture content is determined directly (for example, as a weight loss registered during the drying routine). These methods include oven drying, infrared drying and microwave drying. All three of these methods are thermogravimetric.

When deductive methods are used, the moisture content is determined indirectly. A physical property related to the moisture in the substance is measured (e.g., absorption of electromagnetic rays). These methods include Karl-Fischer titration, infrared spectroscopy, microwave spectroscopy, etc.

Thermogravimetry is the process of determining the loss of mass that occurs when a substance is heated. In this process, the sample is weighed before and after being heated, and the difference between the two weights determined is calculated.

In a conventional drying oven, circulating hot air warms the sample from the outside inwards. Efficiency is lost during drying because as the moisture evaporates, it cools the sample surface.

By contrast, infrared rays (IR rays) penetrate a sample without being impeded. Having reached the interior of a sample, they are converted into heat energy.

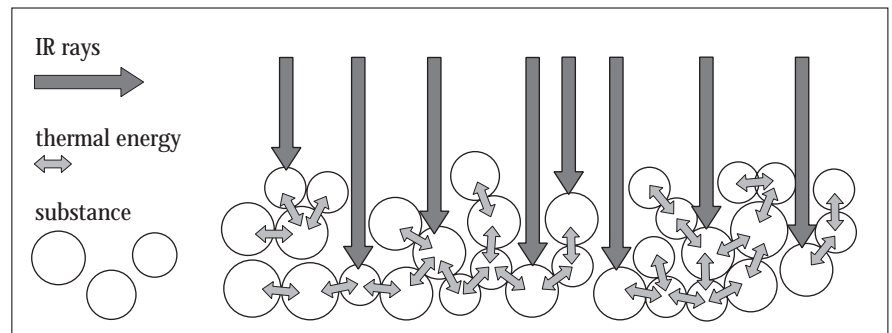

A small percentage of IR rays is reflected by the substance. The quantity of reflected IR rays depends to a great extent on whether the substance is light or dark in color.

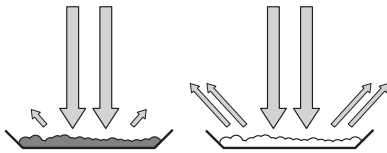

dark substance
low reflection

light substance
high reflection

How the rays penetrate the sample depends on the light-transmitting capacity of the sample. If the light-transmitting capacity is low, rays can only penetrate the uppermost layers of the sample. The heat conductivity of the sample dictates the degree to which the heat can be transmitted to the underlying layers. The higher the conductivity, the faster and more uniformly the substance is heated.

The substance should be applied to the sample pan in a thin, even layer. A height of approximately 2–5 mm for 5–15 g substance weight has proved to be ideal. Otherwise, the sample will not be dried completely or the analysis time will be unnecessarily extended, a crust/skin will form on the surface of the sample or the sample will scorch, and the analysis results obtained will not be reproducible (and therefore cannot be used).

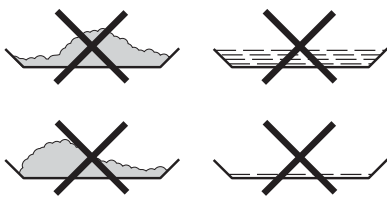

Incorrect application of a sample

When preparing substances for measurement, do not use processes that generate heat, as the heat generated may result in a loss of moisture prior to the measurement.

Perform initial analysis of a new substance to test how the IR rays are absorbed by the sample and converted into heat. A printout of the intermediate values of the drying process provides you with this information at an early stage.

Experience has shown that the temperature setting selected for infrared drying is usually lower than the temperature setting used when working with a drying oven.

In many cases, the fully automatic shutoff mode will meet your requirements. If the final result is higher or lower than expected, try varying the temperature setting before resorting to a different shutoff parameter.

When analyzing the samples that lose their moisture only very slowly or when operating a cold moisture analyzer, the fully automatic mode may end the drying routine too early since no analyzable progress in the drying routine can be detected. In this case, preheat the moisture analyzer for 2–3 minutes before starting the drying routine, or select a different shutoff parameter.

The Sartorius Moisture Analyzer Applications Guide provides you with important information on the use of your moisture analyzer.

Preparation

Make sure you carry out the following preparations prior to drying a sample:

- Adjustment to the available measuring system (if required)
- Sample preparation
- Setting the drying program parameters

Adjustment to an Existing Measuring System

A moisture analysis method often replaces another drying method (such as oven drying method) because it is simple to use and requires shorter analysis time. In this case, you should adapt this method to that of the moisture analyzer in order to obtain values comparable to those yielded by your standard reference method.

- Perform parallel measurements: take a fresh sample and divide it in half
- Determine the moisture content of the first half using your standard method of analysis
- Analyze the second half of the sample in the moisture analyzer.
Use the following settings:
 - fully automatic mode for the shutoff parameter
 - lower temperature settings than for the oven drying method
 - temperature setting for organic substances: 80–100°C
 - temperature setting for inorganic substances: 140–160°C
- If the result of the second analysis does not correspond to that of the first:
 - repeat the analysis first using a different temperature setting
 - then use the semi-automatic mode for the shutoff parameter (for example with a different loss rate per 24 s)
- Vary the shutoff parameter if required:
 - Increase end-point recognition: set the parameter to 2 mg/24 s or 1 mg/24 s
 - Decrease end-point recognition: set the parameter to 10 mg/24 s or 20 mg/24 s

Sample Preparation

Selecting a Sample

- Select a representative part of the whole substance as a sample
 - a representative number of individual samples for quality control
 - samples which indicate a trend are sufficient for in-process control
- If required, homogenize the product before a sample is taken by:
 - mixing or stirring,
 - taking several samples from different areas of the product, or
 - taking several samples at defined intervals
- Take only one sample at a time for a given analysis and prepare it as quickly as possible. This way it will not lose or gain moisture as a result of the ambient conditions.
- If you need to take several samples simultaneously, the samples must be sealed in air-tight containers to ensure that the storage conditions do not alter the state or condition of the samples:
 - Warm or highly volatile substances lose their moisture very quickly.
 - Storing samples in a container may lead to moisture condensing on the walls of the container.
 - If the container is too large, moisture is passed to the air remaining in the container.
- Mix the condensed moisture back in with a sample, if necessary.

Preparing a sample

- When crushing a sample, avoid any contact with heat: Heat results in moisture loss.
- Crush a sample with
 - a pestle
 - a shredder (see below)

For liquids containing solids, use

- a glass stirrer
 - a spoon, or
 - a magnetic stirrer.
- Use an appropriately designed tool for shredding a sample.

Using disposable sample pans

- Use only Sartorius disposable sample pans (inner diameter of 92 mm). Reusing sample pans leads to poor reproducibility of results for several reasons:
 - sample residues can remain on the pan even after cleaning
 - residues from cleaning agents can evaporate during the next moisture analysis
 - scratches and grooves made during cleaning result in damage that forms points of attack for hot, rising air produced during the drying process (more pronounced buoyancy)

Applying a Sample to the Sample Pan

- Apply the sample to the sample pan in a thin, even layer (height: 2 to 5 mm, weight: 5 to 15 g); otherwise:
 - a sample applied unevenly will result in a non-uniform distribution of heat
 - a sample will not be dried completely
 - the analysis time will be prolonged unnecessarily
 - the sample burns or a crust/ skin forms on its surface as a result of a very thick layer
 - the crust makes it difficult or impossible for moisture to escape from the sample during the drying process
 - an uncertain and unknown quantity of moisture remains in the sample



- Apply liquid samples, pasty samples or samples that can melt to a glass fiber filter (order no. 6906940); advantages include:

- uniform distribution due to capillary effect
- liquids prevented from beading together and forming drops
- moisture can evaporate faster with larger surfaces
- considerably more convenient than the “sea-sand method”

When drying samples containing sugar, a crust or skin can form and seal the surface. A glass fiber filter is particularly useful in such cases. The moisture can evaporate downwards through the surface of the filter. You can prevent or limit crust/skin formation by placing the glass fiber filter on top of the sample.

- Cover solid, heat-sensitive samples with a glass fiber filter (order no. 6906940); advantages include:

- gentle heating; sample surface is shielded from excessive heat
- higher temperature setting can be selected
- uniformity of the sample surface
- faster evaporation of the moisture
- excellent reproducibility for samples containing fat

Preventing the formation of crust/skin

Solvents can be applied to the sample to prevent the formation of crust/skin during analysis. The solvent applied has no bearing on the final result of an analysis.

- Re-open the sample chamber within 2 seconds of closing it (after the beep tone).
- Apply a solvent to the sample
- Close the sample chamber and start the analysis as usual

Operating the Moisture Analyzer

Setting the Drying Parameters

Purpose

Adapt the moisture analyzer to the special requirements of products.

Parameters can be configured individually for each program.

Drying Parameters (Overview)

- o Factory settings
- √ User-defined setting

	Factory setting	Factory setting	Factory setting			
Program memory (PROGRAM)	o P1 to P20					
Program name		Blank (max. 16 characters)				
Heating program	o	Standard drying	Temperature	105°C	40 ... 220°C	
		Gentle drying	Temperature	105°C	40 ... 200°C	
			Time	3.0 min.	1,0 ... 20 minutes	
Standby temperature	o	Off				
		On	Temperature	40°C	40 ... 100°C	
Initial weight	o	Off				
		On	Target	5.0 g	0.2 g ... 90% max load	
Start of analysis	o	With stability when Enter pressed				
		Without stability when cover is closed				
End of analysis	o	With stability when cover is closed				
		Without stability when cover is closed				
End of analysis	o	Fully automatic				
		Semi-automatic	Loss	5 mg	1 ... 50 mg	
		Absolute	Time interval	24 s	5 ... 300 s	
		Semi-automatic	Loss	1 %	0.1 ... 5.0 %	
		Percentage	Time interval	60 s	5 ... 300 s	
		Time	15.0 min	0.1 ... 99.9 minutes		
		Manual				
Display mode	o	Moisture (%L)				
		Dry weight (%R)				
		Ratio (%LR)				
		Weight loss (mg)				
		Residue (g)				
		Residue weight (g/kg)				
		Gram/liter (g/l)	Sample	1.0 l	0.0001 ... 9.9999 l	
Print intermediate result	o	Off				
		On	Interval	0.1 min	0,1 ... 10.0 minutes	
Determination of ignition residue	o	Off				
		On				
Headers		Line 1	Empty		max. 20 characters	
		Line 2	Empty		max. 20 characters	
Factory settings		No				
		Yes				

Features

Number of Drying Programs:
20 programs

Programs are listed according to program number.

Heating Programs

Two heating programs are available for performing moisture analysis of a substance:

- Standard drying
- Gentle drying

Standard drying:

The final temperature needs to be entered when using the standard program.

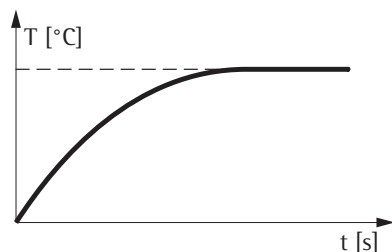

If a target temperature of over 200°C is entered, the moisture analyzer heats to the target and then adjusts to 200°C in 5 phases, from the 10th to the 30th minute.

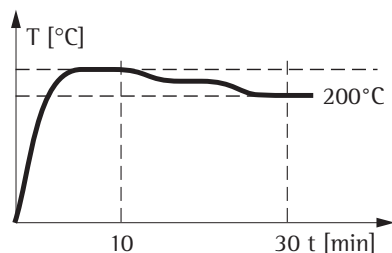

Gentle drying:

Heat up to the target temperature (maximum 200°C) in a selectable time-frame between 1 and 20 minutes.

Standby Temperature

- Temperature set to defined value when the sample chamber is closed

Initial Weight

The target weight (as a guide for applying a sample to the analyzer – not as a starting condition) can be entered by the user. The tolerance limits of $\pm 20\%$ are displayed.

Start of Analysis

- With stability after pressing \cup key:

When **START** is shown in the function line and you press \cup to confirm, the initial weight is stored at stability regardless of whether the cover is open or closed.

- Without stability after the cover is closed:

A prompt to close the cover (a graphic symbol) is displayed once the initial weight condition is met.

The initial weight is stored without stability as soon as the sample chamber is closed.

The analysis starts as soon as a 2-second delay has elapsed after the cover is closed or the sample chamber is opened and then closed (applies to both start criteria).

- With stability after cover is closed: A prompt to close the cover (a graphic symbol) is displayed once the initial weight condition is met.

The initial weight after stability is stored as soon as the sample chamber is closed. There is no additional delay time.

- Interruption of analysis: You can open and close the cover at any time without interrupting the measurement to post-treat samples.

The device status line shows MEASUREMENT PAUSE/MEASUREMENT when you open/close the cover. The drying and heating algorithms stop when the cover is open and continue once it is closed.

End of Analysis with Shutoff Parameters

- Fully automatic
- Semi-automatic, absolute
- Semi-automatic, percentage
- Timer mode
- Manual

Fully automatic:

The analysis ends as soon as the weight loss per 24 s is below an automatically detected threshold.

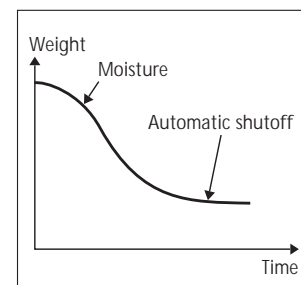

Semi-automatic, absolute:

The analysis ends as soon as the weight loss per 24 s is lower than a user-defined threshold (set in milligrams).

Semi-automatic, percentage:

The analysis ends as soon as the weight loss per 24 s is lower than a user-defined threshold (set in percent). The percentage is entered by the user.

Timer mode:

The analysis ends as soon as the specified time has elapsed.

Manual:

Shut-off with the \cup key.

Display Mode

The following units can be selected for displaying analysis results:

- Moisture %L
- Dry weight %R
- Ratio %LR
- Weight loss mg
- Residual weight g
- Residual weight g/kg
- Gram/liter g/l

Print Intermediate Results

- When set to "Off", intermediate results can only be printed by pressing the r key.
- Intermediate results can be printed out automatically after a configurable time interval.

Determination of Ignition Residue

A two-part measurement can be performed using this setting. Example: Moisture analysis and incineration of sludge. Moisture content is analyzed in the first stage. The sample is then reduced to ashes in the furnace and in the second stage the ash is calculated as a percentage of the initial weight.

CONTINUE is displayed instead of **END** after the first stage.

The moisture analyzer must not be used for other purposes between the first and second stages.

Headers

Text can be entered for the drying report (2 lines each with max. 20 characters). The relevant line is not printed if no text is entered.

Factory Setting

The drying programs can be reset to the factory settings.

Printout of the Analysis Parameters

- When the desired program is displayed: Press the r key

> Printout (example on right). Lines with more than 20 characters are truncated.

Additional Functions

The following functions are supported in the program memory:

- Display programs
- Change settings
- Save program changes

```
-----
14.07.2006      12:40
Model MA150Q-000230V
Ser. no.      18701636
Vers. no.     01-50-01
ID
-----
                PROGRAM
-----
P1
  Program name
  Progr. name:      MEYER
  Heating program
  Standard drying
  Temperature:
                    105 °C
  Standby temperature
                    Off
  Initial weight
                    Off
  Start of measurement
  Without stability,
                    after close
  End of measurement
                    Fully automatic
  Result display
  Moisture          (%L)
  Print intermediate
                    res.
                    Off
  Determination of
  ignition residue
                    Off

  Headers
  Line 1
  Line 1:

  Line 2
  Line 2:
-----
```



Example: Standard Drying with Fully Automatic Shutoff Mode

The moisture content of 2 g of corn starch is to be analyzed. The sample can scorch if overheated but is not particularly heat sensitive. The analysis is to be ended automatically as soon as a constant weight is reached.

Settings (changes in the factory settings):



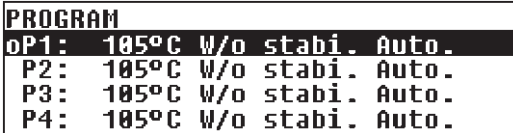
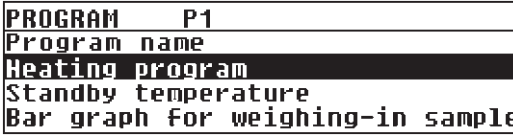
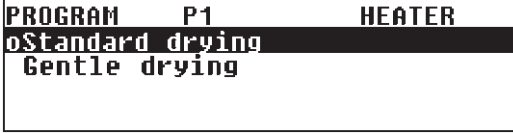

Program number: 1
 Final temperature: 130 °C
 Start of analysis: With stability after Enter key is pressed
 End of analysis: Fully automatic (factory setting)



Part A: Configuring drying parameters

Step	Key (or instruction)	Display/Printout
1. Turn on the moisture analyzer	e	Sartorius logo is displayed Self-test runs
2. Select PROGRAM function	y or x	
3. Confirm the PROGRAM function	u	
4. Select P1 program	u y	
5. Select Heating program	u	
6. Select Standard drying	u	
7. Enter a temperature value of 130	u 3 x x u 5 x y u	

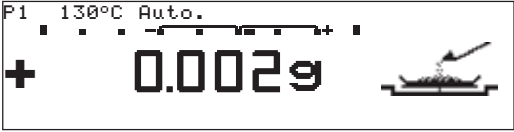
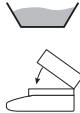
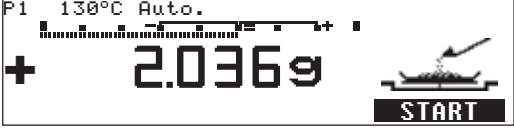
Step	Key (or instruction)	Display/Printout
8. Confirm temperature value	u	<pre>PROGRAM P1 HEATER oStandard drying Gentle drying</pre>
9. Select the Bar graph for weighing-in sample parameter	c 2 x y	<pre>PROGRAM P1 Heating program Standby temperature Bar graph for weighing-in sample Start analysis</pre>
10. Confirm Bar graph for weighing-in sample parameter	u	<pre>PROGRAM P1 BAR GRAPH oInactivated Activated</pre>
11. Select the On setting and confirm	y u	<pre>P1 BAR GRAPH ACTIVATED Target wt: 5.0 g</pre>
12. Enter the target weight 2.0	3 x x u	<pre>P1 BAR GRAPH ACTIVATED Target wt: 2 g</pre>
13. Confirm the target weight	u	<pre>PROGRAM P1 BAR GRAPH Inactivated oActivated</pre>
14. Select the Start analysis parameter	c y	<pre>PROGRAM P1 Heating program Standby temperature Bar graph for weighing-in sample Start analysis</pre>
15. Confirm the Start analysis	u	<pre>PROGRAM P1 START With stability, after ENTER key oW/o stability, after closing With stability, after closing</pre>
16. Select the With stability, after ENTER key setting and confirm	x u	<pre>PROGRAM P1 START oWith stability, after ENTER key W/o stability, after closing With stability, after closing</pre>
17. Exit the PROGRAM function	3 x c	

Part B: Performing the analysis

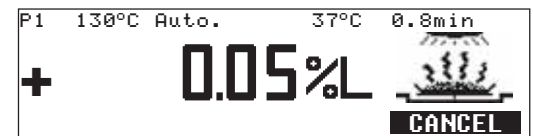
Step	Key (or instruction)	Display/Printout
1. Turn on the moisture analyzer	e	Sartorius logo is displayed Self-test runs 
2. Prepare the sample: Not necessary with corn starch		
3. Open sample chamber and position a new sample pan		
4. Tare the sample pan: Select the TARE function and confirm	y or x as needed u	
5. Distribute approx. 2 g of corn starch evenly on the sample pan Close sample chamber		
6. Start the drying program	u	
The analysis report header is printed after a delay of 2 seconds (printout: see next page)		

Step	Key (or instruction)	Display/Printout
		<pre> ----- 14.07.2006 15:07 Model MA150Q-000230V Ser. no. 18701636 Vers. no. 01-50-01 ID ----- Prg 1 Heating STANDARD Fin. temp. 130 °C Stdbby temp. OFF Start W/stabil. End AUTOMATIC IniWt + 2.036 g </pre>
The current moisture loss is then displayed		
Fully-automatic shut-off of the drying process once no more loss detectable (after 5.2 minutes in this case)		
Then the footer of the analysis report is printed out		<pre> ----- FinWt + 1.814 g 5.2 + 10.90 %L Name: ----- </pre>

“isoTest” Calibration/Adjustment Functions

The following functions are available in the **SETUP** menu, under the **isoTEST** menu item:

- Weighing system adjustment
 - Calibration/adjustment
 - Weighing only
- Hardware tests
 - Interface test
 - Heater test

The following functions are available once the sample pan and the pan support are removed from the sample chamber:

- Heater adjustment
 - 2-point temperature adjustment
 - 1-point temperature adjustment

Heater Adjustment

You can calibrate and adjust temperature settings of the drying unit using 1-point and 2-point temperature adjustments as well as the YTM03MA temperature adjustment set (see “Accessories”).

Weighing System Settings

Calibration/Adjustment

Purpose

Calibration is the determination of the difference between the weight readout and the true weight (mass) of a sample. Calibration does not entail making any changes within the weighing system.





Adjustment is the correction of the difference between the measured value displayed and the true weight of a sample, or the reduction of the difference to an allowable level within maximum permissible error limits.



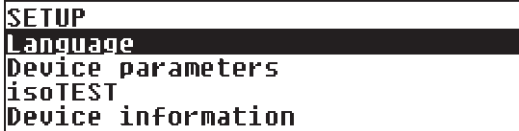
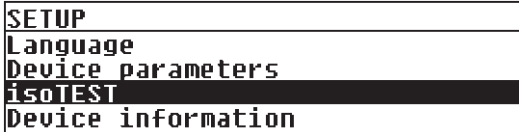
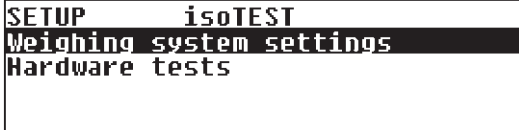

Features

Calibration is performed externally with a 100 g weight (see “Accessories”)

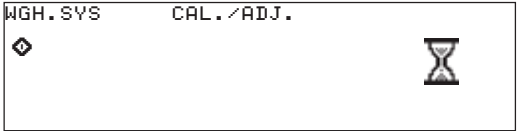
Calibration and adjustment results can be documented as ISO/GLP compliant printouts; see the next page.

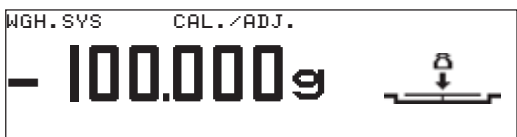
External Calibration/ Adjustment with a Factory-Defined Weight
 External calibration and adjustment of scales using 100 g adjustment weight

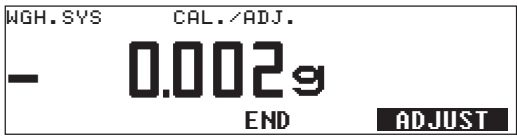
Step	Key (or instruction)	Display/Printout
1. Select SETUP in the Function line	x or y	
2. Confirm SETUP	u	
3. Select isoTEST	2 x y	
4. Confirm isoTEST	u	
5. Confirm Weighing system settings	u	
6. Confirm Calibration/adjustment	u	
7. Unload and tare the weighing system	u	
8. Select the CAL. function	y	
9. Start calibration	u	

Step	Key (or instruction)	Display/Printout
Weighing system is being prepared for calibration The following is displayed when the system is ready for calibration		
10. Place the 100 g calibration weight on the weighing system (here 100.00 g) “-” sign: weight too low “+” sign: weight too high No +/- sign: weight ok	Position the 100 g calibration weight	
At the end of calibration the display shows		
11. If no adjustment is required, select END in the Function line and confirm	y u	<pre> ----- 14.07.2006 15:10 Model MA150Q-000230V Ser. no. 18701636 Vers. no. 01-50-01 ID ----- External calibration W-ID Nom. + 100.000 g Diff. - 0.002 g ----- 14.07.2006 15:12 Name: ----- </pre>
12. If necessary, adjust the weighing system	u	
At the end of adjustment, the display shows		
and a report is printed: (see next page)		

Step	Key (or instruction)	Display/Printout
------	----------------------	------------------

Printout following adjustment:

```

-----
14.07.2006      15:15
Model MA150Q-000230V
Ser. no.      18701636
Vers. no.     01-50-01
ID
-----
External calibration
W-ID
Nom. + 100.000 g
Diff. - 0.002 g
External adjustment
           completed
Diff.      0.000 g
-----
14.07.2006      15:16
Name:
-----

```

13. Unload the weighing system

Hardware Tests

Purpose

Hardware tests are performed to check whether the system communication with internal and external devices is functioning correctly. These tests are not elementary hardware tests.

The following device elements can be tested:

- SBI communication
- Heater



Activating Hardware Tests

Step	Key (or instruction)	Display/Printout
1. Select SETUP in the Function line and confirm	x or y u	<pre> SETUP Language Device parameters isoTEST Device information </pre>
2. Select isoTEST and confirm	2 x y u	<pre> SETUP isoTEST Weighing system settings Hardware tests </pre>
3. Select Hardware Test and confirm	y u	<pre> SETUP isoTEST HARDWARE Test interfaces Heater test </pre>

Testing SBI Communication

Step	Key (or instruction)	Display/Printout
1. Prepare the test connector for the RS-232 port (see Pin Assignment Chart)	Connect TxD (pin 2) with RxD (pin 3)	
2. Select Hardware Test	see above	
3. Select Test interface function and confirm	u	<pre> isoTEST HARDWARE INTERFACE Test SBI communication </pre>
4. Confirm Test SBI communication	u	<pre> HARDWARE INTERFACE SBI Result: </pre>
Once the test is completed the result is displayed: either Test error or Test OK (Test error in this case) (the test is repeated continually)		<pre> HARDWARE INTERFACE SBI Result: Test error </pre>
5. Exit SBI communication test	2 x c	

Testing Digital I/O

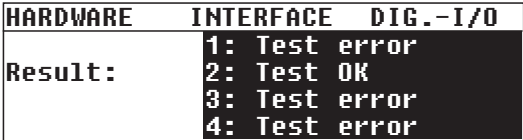
Step	Key (or instruction)	Display/Printout
1. Test connector for RS-232 data output (see "Pin Assignment Chart")	Connect universal key (pin 15) with the digital I/O (pin 16 ... pin 19) tested	
2. Select Hardware Test	see the previous page	
3. Select Test interface and confirm	u	
4. Select Test digital I/O function and confirm	y u	
“Test error” or “Test OK” is displayed for each I/O port. Testing of the first port begins again after the last port		
5. Exit digital I/O test	2 x c	

Testing the Heater

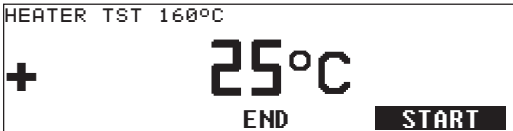
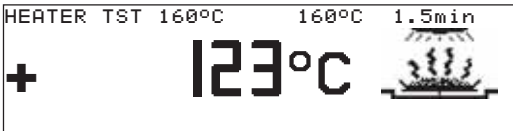
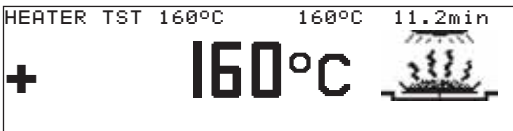
Step	Key (or instruction)	Display/Printout
1. Select Hardware Test	see the previous page	
2. Select Test heater and confirm	y u	
3. Start heater test: START function	u	
If the sample chamber is opened, the test is paused until the sample chamber is closed again		
The device reaches the target temperature after a brief period		
4. Exit heater test	c	

Data Output

There are three options for data output:

- Output to the moisture analyzer
- Output to an external printer (YDP02-0CE or YDP03-0CE)
- Output to a peripheral device (e.g. a computer) via the interface port

Output to the Moisture Analyzer Display (weights and calculated values)

The display is divided into 9 sections. Information on the weighing system, the application being used and the sample weighed is output in the following sections:

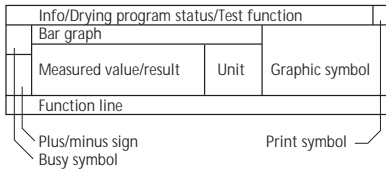

- Info/drying program status/test function
- Print symbol
- Bar graph
- Busy symbol
- Plus/minus sign
- Measured value/result
- Unit
- Graphic symbol
- Function line

Info/Drying program status/Test function

This line shows information on the drying program:

- P1** - Program number
- 105°C** - Temperature data
- Auto.** - Shutoff parameter
- 85°C 5.4min** - Current temperature and time
- HEATER TEST 160°C** - Active test function with parameters

Print Symbol

The print symbol is displayed in this area: after pressing the **r** key or after start and end of moisture measurement.

Bar Graph (Overview Display)

The bar graph shows the target weight with tolerances (-20%, +20%).

The bar graph is displayed if **ON** is selected as the "Initial weight" parameter in the drying program.





Busy Symbol

The Busy symbol is shown here when the moisture analyzer is processing a function activated by pressing a key.



Plus/Minus Sign

The plus or minus sign is displayed here.

Measured Value/Result Line

This line shows:

- 5.234 – the current weight unit
- 17.23 – calculated values (e.g., % moisture)

Unit

This section shows:

- g – the current weight unit (e.g., g)
- °C – the drying temperature unit
- %L – the unit for calculated values (e.g., % moisture)



Graphic Symbol

There are a number of different graphic symbols that can be displayed here; for example, to prompt the next user action (such as “Close cover”), to indicate the current function (sample pan with evaporating moisture) or to indicate internal functions that require some time to complete (e.g. with hourglass).



Function Line

This line indicates the functions that can be activated (inverse display) by pressing “Enter” (e.g., Setup menu, Program menu, “Tare”, “Start”, or “Cal” [calibration]).

If an error occurs, the resulting error code or message overwrites this line.

Interface Port

Purpose

The moisture analyzer has an interface port for connecting an external printer, a status display, a programmable logic controller (PLC) or a computer.

External printer:

Reports and settings may be output to a printer.

Status display:

The status display shows the status of the moisture analysis.

Programmable logic controller:

The PLC shows the status of the moisture analysis and can activate the function of the **u** key via the digital input.

Computer:

Analyses and calculated values can be sent to a computer for further evaluation and documentation.

⚠ Caution when using ready-made RS-232 connector cable:
RS-232 cables purchased from other manufacturers often have incorrect pin assignments for use with Sartorius weighing systems. Be sure to check the pin assignments against the chart on page 44 before connecting the cable and disconnect any lines marked differently (such as pin 6). Failure to do so may damage (or completely ruin) your weighing system and/or peripheral device.

Features

Type of interface:	Serial interface
Interface operating mode:	Full duplex
Standard:	RS-232
Transmission rate:	150; 300; 600; 1200; 2400; 4800; 9600; 19,200 baud
Number of data bits:	7, 8 bit
Parity:	None, odd, even
Number of stop bits:	1 or 2 stop bits
Handshake mode:	Software, hardware 1 character
Operating mode:	SBI, xBPI ¹⁾
Network address ²⁾ :	0, 1, 2, [...], 30, 31
Data output format with SBI:	20 characters + CR LF

¹⁾ xBPI operating mode always with 9600 baud, 8 bits, odd parity, 1 stop bit

²⁾ Network address is valid only in xBPI mode

Factory settings for SBI operating mode parameters:

Transmission rate:	1200 baud
Number of data bits:	7 bits
Parity:	Odd
Stop bits:	1 stop bit
Handshake:	Hardware handshake after 1 character
Operating mode:	SBI

Preparation

- See pages 44 and 45 for the pin assignment chart and cabling diagram.

Data Output Format

The contents of the measured value line and the unit are output with data ID codes.

Example
N + 3.4253 g

20 characters per line are output.

Output format with 20 characters + CR LF

1	2	3	4	5	6	7	8	9	10	11	12	13	14	15	16	17	18	19	20	21	22
I	I	I	I	I	I	+	*	D	D	D	D	D	D	D	*	U	U	U	CR	LF	
*	*	*	*	*	-	*	*	*				
					*	*	*	*	*	*	*	*	*	*							

- I: ID code character
- *: Space
- D: Display character
- U: Unit symbol
- CR: Carriage return
- LF: Line feed

Error Code

1	2	3	4	5	6	7	8	9	10	11	12	13	14	15	16	17	18	19	20	21	22
S	t	a	t	*	*	*	*	*	E	R	R	*	#	#	#	*	*	*	*	CR	LF

- *: Space
- H: Overload
- L: Underload
- ###: Error code number

Digital outputs (status display, programmable logic controller)

The respective status of the moisture analysis is output to digital output pins 16–19 (see pin assignment chart) as per the following table.

Status	Pin16	Pin17	Pin18	Pin19	Description
No moisture analysis	0	0	0	0	No drying program (OFF, STANDBY, SETUP, PROG, ERR xxx)
TARE inactivity	0	0	1	0	Wait for \cup key "TAR"
TARE waiting for tare to complete	0	0	1	1	key \cup , "TAR" confirmed, Waiting for stability
WEIGH IN Apply sample	0	1	0	0	Measured value display
WEIGH IN Start measurement	0	1	0	1	Measured value display
MEASUREMENT PAUSE					
MEASUREMENT started	0	1	1	1	Measured value display
MEASUREMENT Reading display	0	1	1	0	Measured value display
MEASUREMENT END	1	0	0	0	Measured value display
MEASUREMENT CANCEL	1	1	1	0	Measured value display

Remote Operation (Computer)

SBI functions for remote operation are useful if the current device/application status can be read out at any time. This is achieved using the ESC ars_ command (see next page). The response from the device to the ESC ars_ command has the format: XXX xx zz ff.

Device response	Meaning
XXX	Active application
xx	Application status
zz	Cover status
ff	Function of the u key

XXX	Meaning
MAN	Moisture analysis/Setup menu/Program menu
CBA	Cal./adj. scale
CHT	Heater adjustment
CMS	Measurement adjustment
THW	Hardware test

xx	Operating status	Action	Main display
1	TARE	Tare sample pan	Weight value
2	WEIGHING	Apply sample	Weight value
3	WEIGHING	Start analysis	Weight value
4	TARE/MEASUREMENT START	Waiting for stability	Dark
5	TARE	Waiting for tare to complete	Dark
6	START MEASUREMENT	Close sample chamber, delay time running	Weight value
7	MEASUREMENT	Analysis active	Result
8	MEASUREMENT PAUSE	Analysis cover open	Weight value
9	MEASUREMENT END	Analysis ended	Result
14	SETUP/PROGRAM	Configure parameters	Menu display
15	ERROR	L, H, scale error 50, 53, 54	L, H, ERR xxx

zz	Meaning
O	Cover open
C	Cover closed

ff	Meaning
0	No soft key
1	Soft key 1
2	Soft key 2
3	Soft key 3

Data Input Format

Remote Operation (Computer)

The computer connected on the data port can send commands to the weighing system to control functions.

These are control commands and use different formats.

Control commands have up to 26 characters. Transmission of these characters is based on the setup configuration for data transmission.

Control command formats

Format 1:	ESC	!	CR	LF			
Format 2:	ESC	!	#	_	CR	LF	
Format 3:	ESC	!	(alphanumeric character)	_	CR	LF	
Format 4:	ESC	!	#	(alphanumeric character)	_	CR	LF

ESC: Escape
 !: Alphanumeric character
 #: Digit
 _: Underline (ASCII 95)
 CR: Carriage return (optional)
 LF: Line feed (optional)

Format 1 (e.g. ESC K)

!	Meaning
K	Weighing mode 1
L	Weighing mode 2
M	Weighing mode 3
N	Weighing mode 4
O	Block keypad
P	Print
Q	Beep (acoustic signal)
R	Unblock keypad
S	Restart

Format 2 (e.g. ESC x1_)

!#	Meaning
acc	Only SBI commands, no print output
acp	SBI with print output
ars	Read status
kF1	u key
kF2	x key
kF3	y key
kF11	c key
x1	Output device type
x2	Output serial number
x3	Output weighing encoder software version
x4	Output operating unit software version
x5	Output (GLP) ident. no.

Format 3:

!	Meaning
t	Alphanumeric input (max. number of characters depends on display)

Format 4:

!#	Meaning
z5	Input (GLP) ident. no. (max. 14 characters)

Digital Input

(Programmable Logic Controller)

The universal switch input (pin 15) is used for remote operation. The Enter key must be configured in the menu (**Device Setup Ext. switch**).

Barcode Scanner/Additional Keypad

A bar code scanner or additional keypad can be connected to pin 15 and pin 19 of the D-SUB 25 connector (see pin assignment chart). Barcode scanner/additional keypad must be configured in the menu (**Device Setup Ext. switch**). The key assignment of the additional keypad is as follows:

Additional keypad keys	Meaning
F6	x key
F7	y key
F8	u key
F10	c key
F11	r key
Return	u key
Backspace	c key
Cursor up	x key
Cursor down	y key
Cursor right	u key
Esc	c key
Print	r key

Synchronization

During data communication between moisture analyzer and computer, messages consisting of ASCII characters are transmitted via the interface. For error-free data communication, parameters for baud rate, parity, handshake mode and character format must be identical for both units.

You can adapt your moisture analyzer by setting corresponding parameters in the Setup menu.

If you do not connect a peripheral device to the analyzer's interface port, this will not generate an error message.

Handshake:

The Sartorius balance interface (SBI) on the moisture analyzer has transmit and receive buffers. You can define the handshake mode in the Setup menu:

- Hardware handshake (CTS/DTR)
- Software handshake (XON, XOFF)

Hardware handshake:

When using hardware handshake, 1 further character can be transmitted after CTS ("clear to send").

Software handshake:

Software handshake is controlled with XON and XOFF. When a device is switched on, XON must be transmitted to enable any connected device to communicate.

When software handshake is configured in the Setup menu, hardware handshake becomes active after the software handshake.

The data transmission sequence is as follows:

```
Moisture analyzer (transmitting device)  -- byte -->  Computer (receiving device)
-- byte -->
-- byte -->
<-- XOFF --
-- byte -->
-- byte -->
...
(pause)
...
<-- XON --
-- byte -->
-- byte -->
-- byte -->
-- byte -->
```

Transmitting device:

Once XOFF has been received, it prevents further transmission of characters. When XON is received, it re-enables the transmitting device to send data.

Receiving device:

To prevent too many control commands from being received at one time, XON is not transmitted until the buffer is almost empty.

Activating data output:

Data can be output after a print command or automatically and synchronously with the analyzer display.

Data output after print command:

The print command can be sent by pressing `r` or with a software command (Esc P).

Pin Assignment Chart

Female interface connector:
25-pin D-Submini (DB25S) with
screwed fastening

Male Connector Used
(please use connectors with the same
specifications)
25-pin D-Submini (DB25S) with
shielded cable clamp assembly
(Amp type 826 985-1C) and fastening
screws (Amp type 164 868-1)

Pin assignment:
Pin 1: Signal ground
Pin 2: Data output (TxD)
Pin 3: Data input (RxD)
Pin 4: Signal return (TxD/RxD)
Pin 5: Clear to send (CTS)
Pin 6: Internally connected
Pin 7: Internal ground
Pin 8: Internal ground
Pin 9: Reset _ In*)
Pin 10: -12 V
Pin 11: +12 V
Pin 12: Reset _ Out*)
Pin 13: +5 V
Pin 14: Internal ground
Pin 15: Digital input or barcode
scanner/additional keypad
Pin 16: Digital output
Pin 17: Digital output
Pin 18: Digital output
Pin 19: Digital output or barcode
scanner/additional keypad
Pin 20: Data terminal ready (DTR)
Pin 21: Supply voltage ground "COM"
Pin 22: -
Pin 23: -
Pin 24: +10 V
Pin 25: +5 V

*) = Hardware restart

Cabling Diagram

- Diagram for interfacing a computer or other peripheral device to the moisture analyzer using the RS-232/V24 standard and cables up to 15 m in length

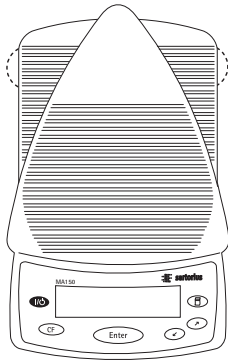

Moisture analyzer

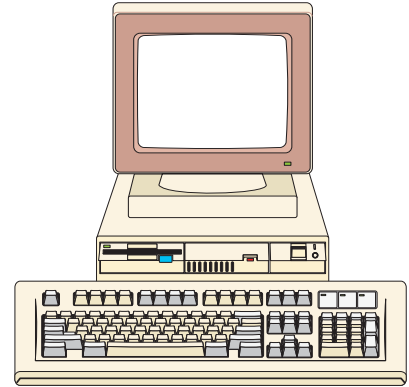
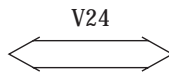

Peripheral device

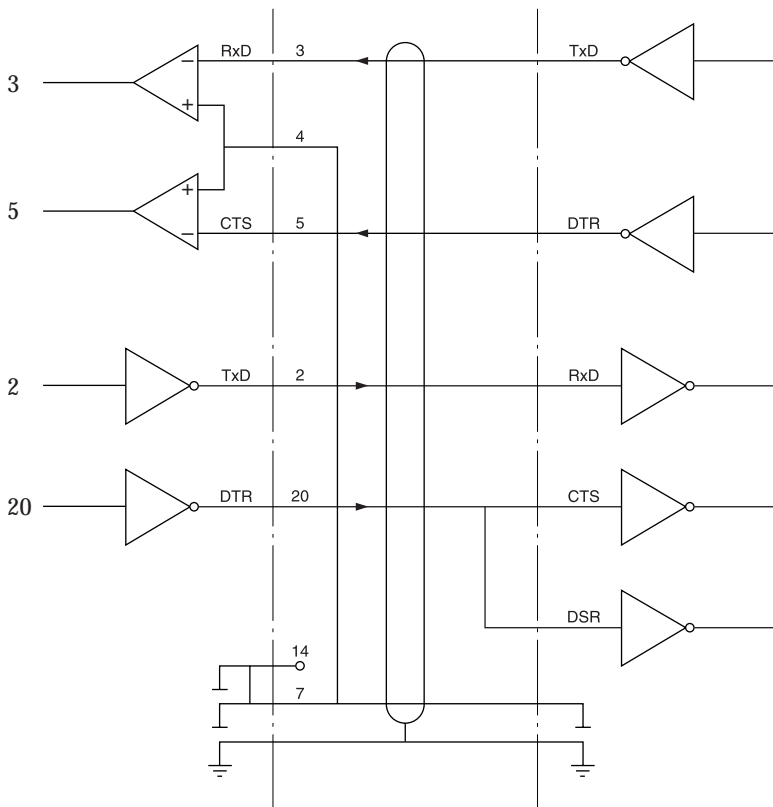

PC 25-pin	or	PC 9-pin
2		3
20		4
3		2
5		8
6		6
7		5

Cable type as per AWG 24

Error Codes

Error codes are displayed for approximately 2 seconds in the main display or text line. The program then returns automatically to the previous status.

Display	Cause	Solution
No segments appear on the display	No AC power available Power cord not plugged in Fuses are defective	Check AC power supply Plug in power cord Replace fuses
H	The load exceeds the weighing capacity	Unload pan support
L or ERR 54	Pan support is not in place	Place pan support on weighing system
ERR 01 > Display range	Data output not compatible with output format	Configure correct setting in Setup
ERR 02 Cal. not possible	Calibration/adjustment condition not met, e.g.: – not tared – pan support is loaded	Calibrate only when zero is displayed Press the TARE function key Unload the moisture analyzer
ERR 03 Cal/adj. abort	Calibration/adjustment could not be completed within a certain time	Allow the moisture analyzer to warm up again and repeat the adjustment process
ERR 30 Print blocked	Interface port for printer output is blocked	Have the port setting changed by Sartorius Customer Service
ERR 31 Print blocked	External device not ready to receive (interface handshake timeout “XOFF, CTS”)	Transmit XON, then CTS
ERR 53 No moisture analysis	No temperature compensation	Contact the Sartorius Service Center
ERR 101 “Checkerboard” pattern displayed continuously	Key is stuck or Key pressed when switching on u key pressed on power-on or is stuck	Release key or Contact the Sartorius Service Center
ERR 320	Operating program memory faulty	Contact the Sartorius Service Center
ERR 340	Incorrect operating parameter (EEPROM)	Contact the Sartorius Service Center
ERR 341	Battery for drying program is flat	Leave device switched on for at least 10 hours
ERR 342	Operating parameters (EEPROM) are wrong with exception of adjustment parameters	Contact the Sartorius Service Center
NO WP blocked	Weighing system is defective Function blocked	Contact the Sartorius Service Center None
xxxxx too low xxxxx too high	Incorrect input (possible with all application programs), e.g., alphabetic input not permitted	Follow the instructions for the application programs

Troubleshooting: See next page

Display	Cause	Remedy
What should I do if ...	The selected temperature is too high and the sample oxidizes Sample boils or scorches and the splashes continually change the sample weight	<ul style="list-style-type: none"> – Reduce drying temperature – Put a glass-fiber filter on top of the sample – Reduce the sample quantity or distribute more evenly – Select a semi-automatic shutoff parameter or select timer mode
	Analysis time too long	<ul style="list-style-type: none"> – Increase temperature – Reduce sample quantity – Dry 2 to 3 minutes with empty disposable sample pan (pre-heat)
	Sample loses weight prior to start of analysis	<ul style="list-style-type: none"> – Remove the sample pan and apply sample outside the sample chamber
	Sample is liquid or pasty	<ul style="list-style-type: none"> – Use a glass fiber filter
	Sample has only a low moisture content	<ul style="list-style-type: none"> – Increase sample quantity
	Insufficient heat output	<ul style="list-style-type: none"> – Clean temperature sensor
	Place of installation unstable (vibrations, etc.)	<ul style="list-style-type: none"> – Change the place of installation

Please contact the Sartorius Service Center if any other problems occur.

Care and Maintenance

Service

Regular servicing by a Sartorius technician will extend the service life of your moisture analyzer and ensure its continued weighing accuracy. Sartorius can offer you service contracts with your choice of regular maintenance intervals ranging from 1 month to 2 years.

Maintenance intervals depend on operating conditions and individual tolerance requirements.

Repairs

Repair work must only be carried out by trained service technicians. Any attempt by unqualified personnel to carry out repair work may result in hazards for users.

Cleaning

Depending on the type of sample, cooling vapors may condense on the cover and result in discoloring of the cover. This is not detrimental to the operation of the device.

⚠ Make sure that no dust or liquid penetrates the moisture analyzer housing

⚠ Do not use any aggressive cleaning agents (solvents, abrasive cleaning agents, etc.); clean the moisture analyzer with a cloth moistened with a mild detergent (soap) only

● Isolate from supply voltage: Unplug the power cord from the wall outlet (mains supply). Unplug any connected data cables from the analyzer

○ The pan draft shield and the pan support can be removed for cleaning

● Carefully remove any sample residue/spilled powder using a brush or hand-held vacuum cleaner

● Wipe down analyzer with a soft, dry cloth after cleaning

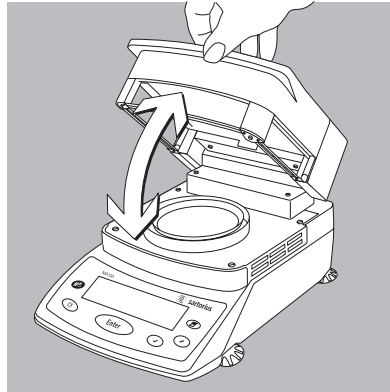

Cleaning the Heating Unit and Temperature Sensor

● Open the hood

⚠ Danger: The terminals of the heating unit are under live current

● Isolate from Supply Voltage: Unplug Power Cord. Disconnect data cables from moisture analyzer

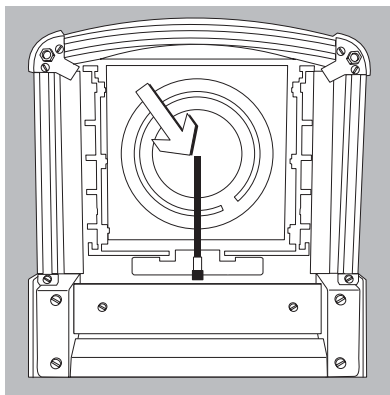

● Carefully remove any residues from the temperature sensor

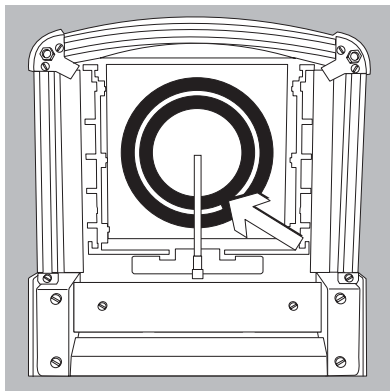

● Use a soft-bristled brush or a commercially available cleaning agent for glassware to clean the ceramic heating element.

● Use a commercially available glass cleaner to clean the protective glass on the quartz-rod radiator.

Safety Inspection

If there is any indication that safe operation of the moisture analyzer can no longer be guaranteed:

- Isolate from supply voltage:
Unplug power cord.
 - > Lock the equipment in a secure place
- Safe operation of the moisture analyzer can no longer be guaranteed if:
- There is visible damage to the moisture analyzer or power cord
 - The moisture analyzer no longer functions properly
 - The moisture analyzer has been stored for a relatively long period under unfavorable conditions
 - The moisture analyzer has been subjected to rough handling during shipment

In this case notify your nearest Sartorius Service Center. Maintenance and repair work may be carried out only by service technicians

- who have access to the required maintenance manuals
- who have attended appropriate service training courses

We recommend that the moisture analyzer be inspected by a qualified Sartorius service technician to check the following specifications:

- Resistance of the protective grounding conductor $< 0.2 \text{ Ohm}$ as measured with a commercially available multimeter
- Insulation resistance $> 2 \text{ MOhm}$ as measured with a constant voltage of at least 500 volts at a 500 kOhm load

The duration and number of measurements should be determined by a qualified Sartorius service technician based on the particular ambient and operating conditions at the place of use (once a year as a minimum).



Information and Instructions on Disposal and Repairs

Packaging that is no longer required must be disposed of at the local waste disposal facility. The packaging is made of environmentally friendly materials that can be used as secondary raw materials.

The equipment, including accessories and batteries, does not belong in your regular household waste. The European legislation requires that electrical and electronic equipment be collected and disposed of separately from other communal waste with the aim of recycling it.

In Germany and many other countries, Sartorius AG takes care of the return and legally compliant disposal of its electrical and electronic equipment on its own. These products may not be placed with the household waste or brought to collection centers run by local public disposal operations – not even by small commercial operators.

For disposal in Germany and in the other member nations of the European Economic Area (EEA), please contact our Service technicians on location or our Service Center in Goettingen, Germany:

Sartorius AG
Service Center
Weender Landstrasse 94–108
37075 Goettingen, Germany

In countries that are not members of the European Economic Area (EEA) or where no Sartorius subsidiaries or dealerships are located, please contact your local authorities or a commercial disposal operator.

Prior to disposal and/or scrapping of the equipment, any batteries should be removed and disposed of in local collection boxes.

Sartorius AG will not take back equipment contaminated with hazardous materials (ABC contamination) – either for repair or disposal. Please refer to the accompanying leaflet/manual or visit our Internet website (www.sartorius.com) for comprehensive information that includes our service addresses to contact if you plan to send your equipment in for repairs or proper disposal.

Overview

Specifications

Model	MA150
Dryer functions:	
Heating element	Ceramic/quartz-rod IR heater
Temperature range	40 to 220 °C
Temperature increments	Adjustable in 1 °C increments
Temperature adjustment	With YTM03MA/YTM05MA temperature adjustment set
Weighing functions:	
Weighing capacity	150 g
Readability	1 mg, 0.01% moisture content
Repeatability, typical (%)	Sample weight 1 to 5 g: 0.2% Sample weight 5 g and over: 0.05%
External calibration weight (with an accuracy of at least...)	100 g (E2)
Sample pan dimensions	Ø 90 mm
Drying parameters:	
Heating programs	Standard; gentle drying
Drying time	0.1 to 99.9 minutes
Number of stored programs	20
Shutoff criteria	Fully-automatic, semi-automatic (absolute, percentage), timer mode (1 + 99.9 min.), manual
Display of analysis results	Moisture, dry weight, ratio, weight loss, residue (g or g/kg), g/l (with specification of sample quantity)
Minimum sample weight	0.100 g
Analyzer (hardware):	
Dimensions (W × D × H)	213 × 320 × 181 mm
Net weight, approx.	5.1 kg
Voltage	230 V or 115 V (depending on model variant), -15% to +10%
Frequency	48 – 60 Hz
Fuses	2 (neutral conductor/phase), 6.3 AT, 5 × 20 mm (internal)
Operating temperature range	+10 ... +30 °C
Power consumption	700 VA max.
Built-in interface	RS-232C
Format:	7 bit ASCII, 1 start bit, 1 or 2 stop bits
Parity:	odd or even
Transmission rates:	150 to 19,200 baud
Handshake:	Software or hardware
Digital input:	1, configurable function
Digital outputs:	4, moisture analysis status

Accessories (options)

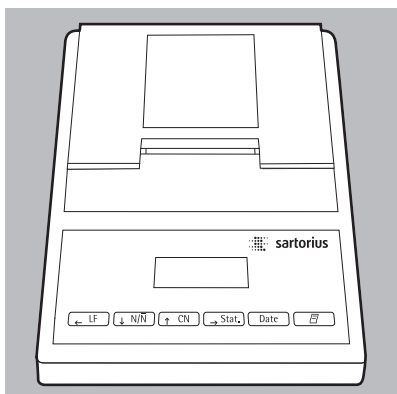

Product	Order No.
External printer	YDP03-0CE
Printer expendables:	
- 5 paper rolls	69 06937
- Ink ribbon	69 06918
Temperature adjustment set	YTM03MA
Exchangeable panels for flip-open cover (aluminum) (not recommended for analyzers with a quartz-rod radiator, models MA...Q)	YDS04MA
Carrying case	YDB05MA
Software for recording moisture analysis values	YMW02MA
Expendables:	
- 80 disposable sample pans, 90 mm Ø (aluminum)	69 65542
- 80 glass fiber filters (for liquid samples)	69 06940
Interface cable (RS-232/25-pin)	69 57312
Calibration weight:	
- 100 g (E2)	YCW5128-00
Standard operating procedure (SOP) For Working with a Moisture Analyzer (For Quality Assurance Documentation)	YSL02A
Spare parts:	
Dust cover for keypad	6960MA02
1 pair of forceps	69MA0072

Other spare parts can be ordered directly through your local Sartorius Service Center.



**Declaration of Conformity
to Council Directives 89/336/EEC and 73/23/EEC
(amended by Directive 93/68/EEC)**

**The electronic moisture analyzer of the series
MA45/145/150/-...../IR60.-.....**

meets the applicable requirements of the test standards listed below, in conjunction with the associated auxiliary peripheral devices and installation equipment listed in Annex A2 (see Annex A1 for a technical description and a list of the individual versions).

1. Electromagnetic Compatibility

1.1 Source for 89/336/EEC: Official Journal of the European Communities, No. 2005/C246/01

EN 61326 Electrical equipment for measurement, control and laboratory use
EMC requirements

Limitation of emissions: Residential areas, Class B

Defined immunity to interference: Industrial areas, continuous unmonitored operation

2. Safety of Electrical Equipment

2.1 Source for 73/23/EEC: Official Journal of the European Communities, No. 2005/C284/01

EN 61010 Safety requirements for electrical equipment for
measurement, control and laboratory use

Part 1: General requirements

EN 61010-2-010 Particular requirements for electrical equipment for measurement,
control and laboratory equipment for the heating of materials

2.2 Certificate (CB Test Certificate) :

IEC 1010-1 and IEC 1010-2-10 and UL 3101-1 and CAN/CSA C22.2 No. 1010.1-92:
UL Ref. Certif. No. E177364, 01ME17489

Sartorius AG
37070 Goettingen, Germany
2006

C. Oldendorf
Vice President, R&D
Technological Operations & Innovations
Mechatronics Division

Dr. D. Klausgrete
Head of
International Certification Management
Mechatronics Division

Index

	Page		Page
Accessories	2, 4, 31, 51	Key description	9
Acoustic signal	14, 17	Keypad	2, 5
Adjustment	31, 46	Levelling	8
Adjustment to existing measuring system	21	Operating design	9
Application status	2	Operation	24
Barcode scanner	42	Options	2, 4, 8, 51
Cabling diagram	45	Package contents	5
Calibration	31, 38	Password	2, 12, 14, 54
Care	48	Pin assignment chart	44
CE marking	52	Power supply connection	6
Cleaning	2, 4, 8, 22, 48	Power-up	8, 27, 29, 43, 46
Configuring the moisture analyzer	13, 27	Preparation of sample	21
Contents	3	Principles of moisture analysis	19
Data output	11, 37, 43, 46	Print intermediate results	25
Data output format	40	Printer	2, 5, 7, 11, 14, 33, 37, 39, 51
Data input format	42	Printout	15, 18, 20, 26, 29, 34
Data interface	6, 7, 11, 37, 39, 46	Programs	2, 12, 14, 25, 38, 50
Determination of ignition residue	24, 26	Repairs	48
Device-specific information	18	Replacing fuses	46, 50
Digital input	42	Result display	24, 50
Digital output	40	Start measurement	24
Display	2, 6, 9, 14, 37, 43	Safety information	4, 8
Display contrast	14	Safety inspection	49
Disposal	5	Safety precautions	7
Drying parameters	2, 24, 50	Sample chamber	8, 23, 25, 29, 31, 36
Drying programs	12, 14, 25, 38	Service	48, 51
Drying temperature	10, 38, 47	Setting date	8
End criteria	25	Setting device parameters	14
End of measurement	24	Setting language	8, 13
Entering/changing password	14	Shutoff criteria	20, 37, 45
Entering digits	9	Software handshake	17, 43
Entering letters	9	Specifications	50
Entering text	9	Standard drying	24
Error codes	12, 43, 46	Standby temperature	25
Examples	10, 13, 15, 16, 18, 26, 40	Storage and shipping conditions	5, 49
Factory settings	12, 17, 24, 27, 39	Synchronization	43
General Password	12, 14, 54, appendix	Testing heater	36
General view of moisture analyzer (overview)	6	Time of day	8, 13, 33
Gentle drying	24	Unpacking	5
Getting started	4	Voltage	5, 7, 48, 50
Guarantee	5	Warmup time	7, 46
Handshake	14, 17, 39, 43, 46, 50	Warning and safety information	4
Hardware test	31, 35	Weighing system settings	31
Heater adjustment	31		
Heating unit	4 f, 7, 48, 51		
Heating program	2, 11, 24, 50		
Initial weight	10, 24, 37, 50		
Installation instructions	5		
Intended use	2		
Interface	9, 11, 14, 31, 35, 39, 46, 50		
Interface test	31, 35		
isoTEST	12, 18, 31		

General Password

Enter/Change Password

- Select the Setup menu:
Select **SETUP** in the Function line
x or y

- Press **u**

> **SETUP** is displayed with submenus

- Select a submenu (in this example, "Device parameters"):
Press the **y** key and press **u** to confirm

> Password prompt is displayed.

SETUP	PASSW.CHECK
Enter password:	██████████

- Enter all of the password characters using **x** and **y** and press **u** to confirm

- Press **u** to confirm password

- Display device parameters:
Press the **y** and **u** keys

> Device parameters are displayed:

- Select the password function:
Press **u**

> Password prompt is displayed, together with current password

- Enter a new password:
Enter all of the password characters using **x** and **y** and press **u** to confirm

- To delete user password, enter a space and press **u** to confirm

- Exit Setup menu:
Press the **c** key twice

> Restart your application

General Password: 40414243
